

BMW R18 '20-

M O U N T I N G I N S T R U C T I O N S

REF 20527

CARENABRÍS NG TOURING / WINDSHIELD NG TOURING



1 Person



30 min



EASY







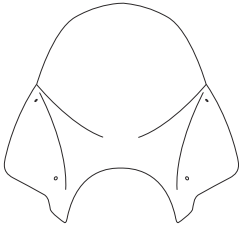
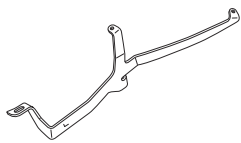
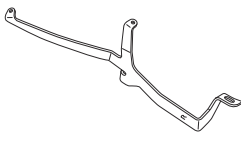

TORX

T27
T40

ALLEN

Nº 3

ID	PIEZA/PART	DESCRIPCIÓN	DESCRIPTION	QTY	REF
1		Cúpula Touring	Touring Screen	1	10043HM3
2		Soporte Izquierdo	Left support	1	SOPOR2P7-L20527
3		Soporte derecho	Right support	1	SOPOR2P7-R20527
4		Casquillo Ø13 x Ø8,5 x 6mm	Ø13 x Ø8,5 x 6mm Arrowhead	2	CASQUI-----776
5		Tornillo M8x45 ISO7380 CABEZA TX (INOX)	M8x45 ISO 7380 TX screw (INOX)	2	TORNI-I7380-870
6		Arandela de goma Ø4,5 x Ø11 x 2mm	Ø4,5 x Ø11 x 2mm Rubber washer	4	ARAND-EPDM--722
7		Arandela de nylon M5x1	M5x1 Nylon washer	4	ARNV0000000245
8		Tornillo Allen M5x16 Ø11 ISO 7380	M5x16 Ø11 ISO 7380 Allen screw	4	TORNI-AI----520
9		Tapón tornillo M5 ISO 7380	M5 ISO 7380 screw cap	4	TAPON-----85

BMW R18 '20-

INSTRUCCIONES DE MONTAJE - MOUNTING INSTRUCTIONS - MONTAGEANLEITUNG

1

DISASSEMBLY
DESMONTAJE

Se muestra el montaje del lado izquierdo a modo de ejemplo, realizar los mismos pasos para el montaje del lado derecho.
The left side assembly is shown as an example, so the same steps can be performed for the right side assembly.

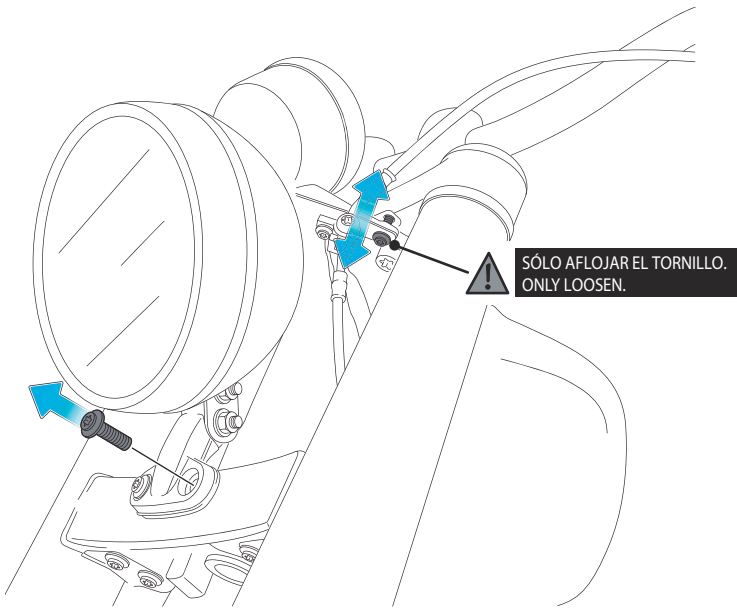

2

ASSEMBLY
MONTAJE

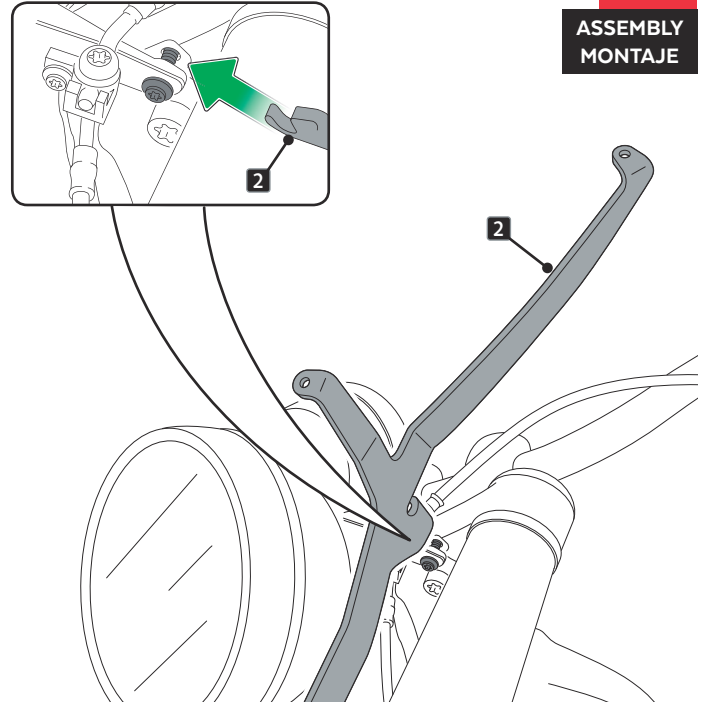

3

ASSEMBLY
MONTAJE

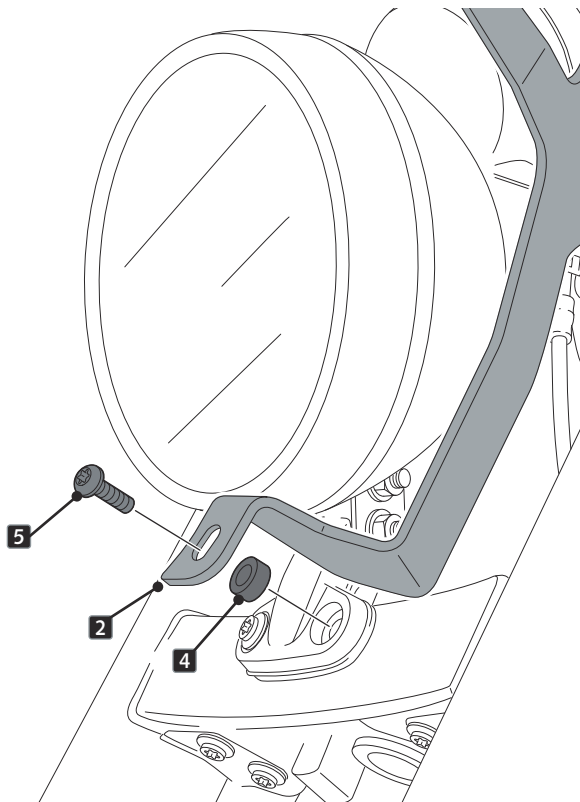

4

ASSEMBLY
MONTAJE

