

**CONTRAPESO SPEED  
BAR ENDS SPEED**

REF 21036N

**M O U N T I N G I N S T R U C T I O N S**



1 Person



15 min



EASY

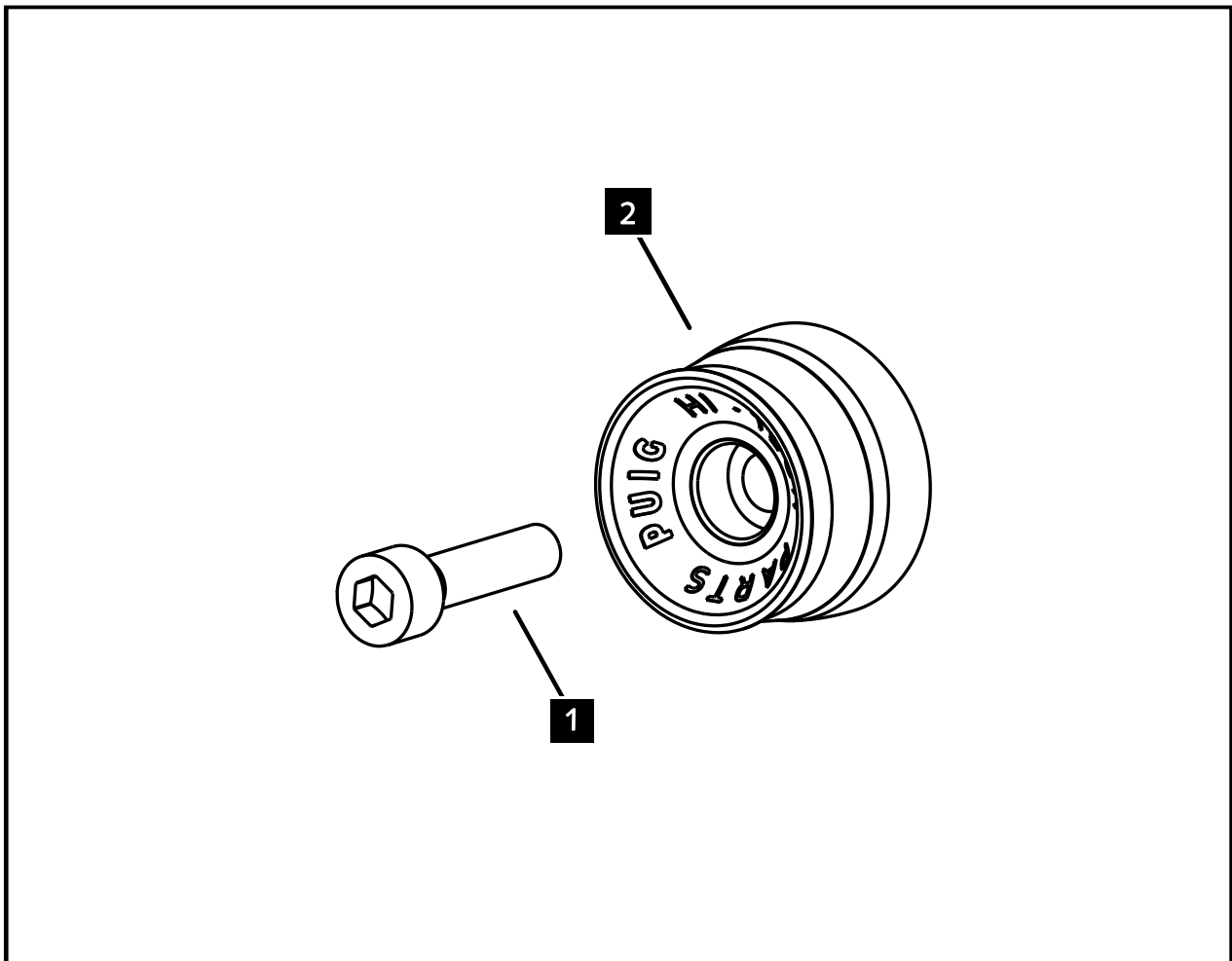

ID.	DESCRIPCIÓN	DESCRIPTION	QTY.
1	Tornillo M6x25 DIN912	M6x25 DIN912 screw	2
2	Contrapeso	Bar end	2

**CONSULTAR EN NUESTRA PAGINA WEB LA DISPONIBILIDAD DEL VIDEO DE MONTAJE DE ESTA REFERENCIA.  
CONSULT OUR WEBSITE THE VIDEO MOUNT AVAILABILITY OF THIS REFERENCE.**