

BMW S1000R '21-

M O U N T I N G I N S T R U C T I O N S

REF 21135

DOWNFORCE NAKED F RONTAL SPOILER - ALERONES DOWNFORCE FRONTALES NAKED



1 Person



15 min









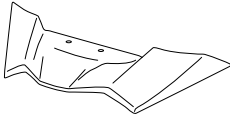

EASY



TORX
T30

ALLEN
Nº 5

ID	PIEZA/PART	DESCRIPCIÓN	DESCRIPTION	QTY	REF
1		Aleron frontal naked	Frontal Naked spoiler	1	21135J/C M3
2		Soporte	Support	1	SOPORIP2--21135
3		Casquillo con valona Ø15x Ø9 x7,5	Ø15x Ø9 x7,5 Bush with flange	2	CASQUI-1A---324
4		Silentblock Ø18x Ø9 xØ11 x7,5	Ø18x Ø9 xØ11 x7,5 silentblock	2	SILENBGONE--064
5		Casquillo Ø13x Ø8 x 12mm	Ø13x Ø8 x 12mm Arrowhead	2	CASQUI-M----769
6		Arandela grower M6 DIN127	M6 DIN127 grower washer	2	ARAND-D127--528
7		Tornillo M6x55 DIN912	M6x55 DIN912 screw	2	TORNI-AD912-453
8		Tope de goma Ø3,7-3,8 x 3,2mm	Ø3,7-3,8 x 3,2mm Bumper foot	1	TOPE--POF-40022

* Algunos componentes se suministran montados.
Some components are supplied assembled.

BMW S1000R '21-

INSTRUCCIONES DE MONTAJE - MOUNTING INSTRUCTIONS - MONTAGEANLEITUNG

1

DISASSEMBLY
DESMONTAJE

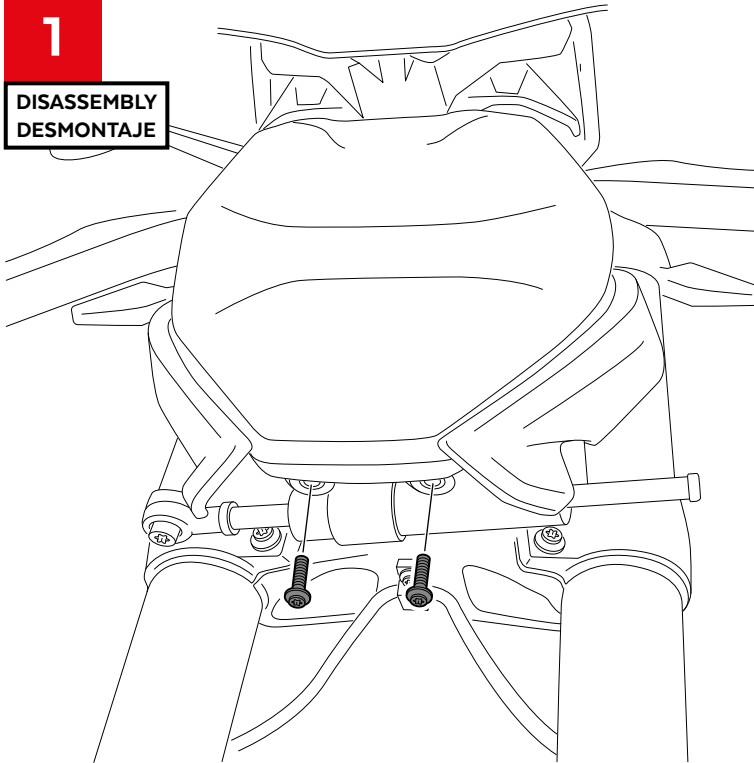

2

ASSEMBLY
MONTAJE

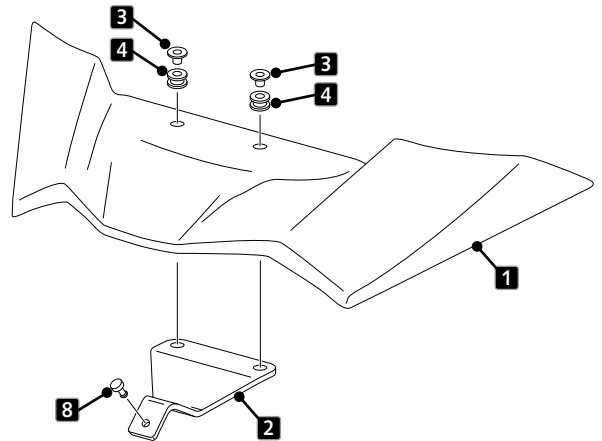

3

ASSEMBLY
MONTAJE

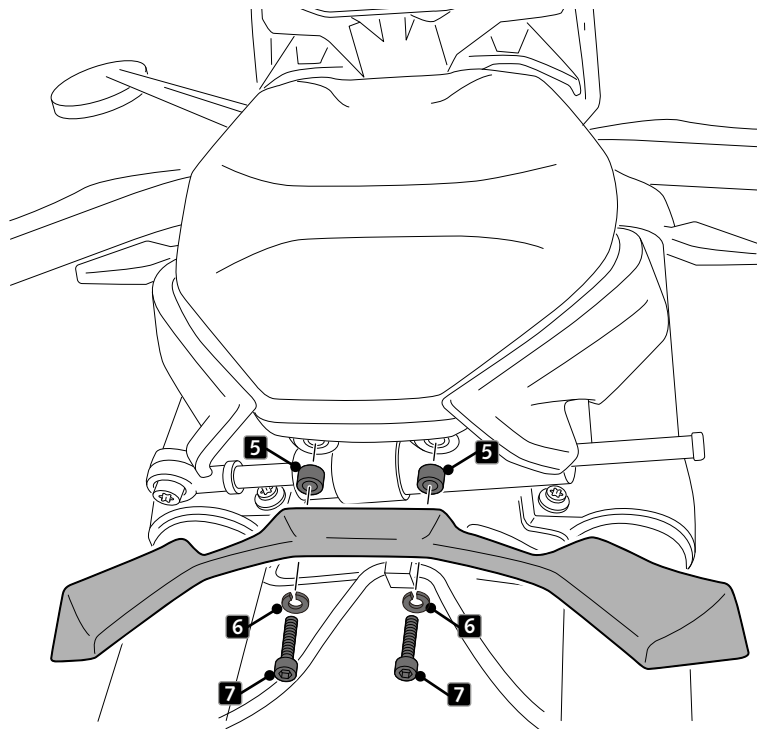

7  Par de apriete - 6 Nm
Tightening torque - 6 Nm